



**Jersey Central
Power & Light**

A FirstEnergy Company

MUNICIPAL LIGHTING HANDBOOK

June 2023



This Municipal Lighting Handbook (the “Handbook”) has been developed to provide information regarding the street light options that Jersey Central Power & Light Company (“JCP&L” or the “Company”) offers, along with corresponding installation charges and monthly rates (based on JCP&L’s applicable Tariff for Service – BPU no. 13, Electric, (the “Tariff”), effective December 1, 2020, or as otherwise indicated herein for applicable rate schedules). It also contains directions on how to apply for new streetlights, upgrades or removals, and how to report street light problems to the Company.

As a convenience, a listing of Company approved street light manufacturers has also been included on pages 30 through 33, along with website addresses where the latest photometric data can be found for the lighting fixtures that are offered. These websites also contain lighting design software that you may find helpful. You may contact JCP&L at 1-800-662-3115 for answers to any street lighting questions or concerns that are not addressed in this Handbook. You may also contact the Regional External Affairs Consultant responsible for your Municipality for any questions and concerns you might have regarding street lighting. Regional External Affairs Consultant contact information is listed on pages 28 & 29.

This Handbook is subject to amendment from time to time and will be re-issued on an as-needed basis. It is the responsibility of the user to obtain the most current version, which can be located at www.jcp-l.com. The current edition of this Handbook supersedes all previous issues and instructions. The Tariff rates used to derive the “Monthly Cost” and the “Monthly Rate” throughout this version are based on rates, effective June 1, 2023, and are subject to change.

The information contained within this Handbook is supplementary to, and does not intentionally conflict with, the Company’s current applicable tariffs, or such applicable State and Municipal Laws and Ordinances as may be in force within the states, cities, towns, or communities in which the Company furnishes electric service. It is always necessary to refer to, and comply with, applicable state statutes, rules and regulations, local ordinances, and the Company’s Tariff, as on file with, and approved by, the New Jersey Board of Public Utilities (“NJBP”U”). To the extent that any included information contradicts any terms in the Company’s current applicable Tariff, the Tariff provision shall govern. This information is general and does not include every detail or every lawful requirement.

INTRODUCTION.....	1
ELIMINATION OF MERCURY VAPOR STREET LIGHTS.....	2
OUTDOOR LIGHTING SERVICE (Floodlights and Area Lights).....	2
STREET LIGHTING SERVICE OPTIONS.....	3
APPLICATION PROCEDURE FOR STREET LIGHTING.....	4
Installation of New Street Lights.....	4
Upgrading Existing Street Lights.....	5-6
Removal of Existing Street Lights.....	7
STREET LIGHTING OPTIONS - OVERHEAD.....	7
Standard Lighting Bracket Options.....	8
1. Standard Cobra Head SVL.....	9-10
2. Colonial Standard SVL Side-Mounted.....	11
3. Ornate Colonial SVL Side-Mounted	12
STREET LIGHTING OPTIONS - UNDERGROUND.....	13
1. Colonial Post Top Sodium Vapor Luminaire.....	14
2. Ornate Colonial Post Top SVL on 16' Fiberglass Pole - I.....	15
3. Ornate Colonial Post Top SVL on 12' 9" Ornate FG Pole - II.....	16
4. Ornate Acorn Style Post Top SVL on 12' 9" Ornate FG Pole.....	17
5. Cobra Head Sodium Vapor Luminaire on 30' Fiberglass Pole.....	18
6. Cobra Head Sodium Vapor Luminaire on Aluminum Pole.....	19
LED STREET LIGHTING.....	20
LED Lighting Options.....	21
1. Standard Cobra Overhead - LED.....	22
2. Post Top Colonial Style -Underground - LED.....	23
3. Post Top Acorn Style -Underground - LED.....	24
4. Cobra Head on 30' Fiberglass Pole Underground - LED.....	25
5. Cobra Head on Aluminum/Steel Pole - Underground - LED.....	26
STREET LIGHT MAINTENANCE PROCEDURE.....	27
On - Line Street Light Outage Report Form.....	27
External Affairs Consultants Central Region.....	28
External Affairs Consultants Contact Information Central Region.....	28
External Affairs Consultants Northern Region.....	29
External Affairs Consultants Contact Information Northern Region.....	29
APPROVED STREET LIGHT MANUFACTURERS.....	30-33
COST COMPARISON BASED ON LUMENS & TYPE OF LIGHT.....	34

INTRODUCTION

The purpose of this Handbook is: to provide guidance on the application process for new or upgraded street lighting installations along public roadways; to catalog the Street Lighting Options that are available from JCP&L; and to provide information on the installation costs and monthly rates for each of these Lighting Options. (Please note that the monthly rates provided in this Handbook are subject to change.)

JCP&L does **not** make lighting recommendations and does not provide street lighting **design** service. It is up to the Municipality to specify the desired level of illumination for a given location with the corresponding bracket size. However, the Company will provide a street lighting **layout** once the Municipality has decided on the appropriate spacing for the type of street lighting fixtures selected. As a convenience, photometric data that you will need to develop a street lighting design can be obtained from the various lighting manufacturers' websites listed on pages 30 - 33.

The Company's Tariff provides for three basic types of lighting service: Light Emitting Diode Street Lighting (LED), Sodium Vapor Street Lighting (SVL) and Outdoor Lighting. The typical street lighting installation is overhead construction comprised of a Cobra Head fixture on a wood distribution pole, known as a "**fixture**" pole. The Company also offers decorative Colonial type luminaires that can be installed on fixture poles. There are also several streetlights offered for installation in underground residential service areas, including the standard Colonial Post Top, as well as more decorative street Lighting Options.

Please note that the Company will no longer install streetlights for the illumination of Municipal parking lots, driveways, walkways, or Park & Ride facilities. The Company will only install streetlights along public rights-of-way for the illumination of roadways.

Also, the Company will no longer install decorative lighting for "streetscape" projects where a Municipality constructs a "downtown" area revitalization project. Private electrical contractors are available for streetscape installations, and JCP&L will coordinate service requirements for the new lighting fixtures, either metered or unmetered (in extraordinary circumstances) service (see paragraph on "Customer Fixtures," page 3).

Revisions to this Handbook will be posted on JCP&L's website as soon as practicable after they are made, but revisions may be effective prior to their posting. For more details on JCP&L's Street and Outdoor Lighting Service, refer to the Company's Tariff at www.firstenergycorp.com/njtariffs. Select JCP&L as the operating company, and then click on Tariff under General Information in the lower left corner of the screen. Refer to the Current **Tariff Part III, "OL", "SVL" or "LED"**.

ELIMINATION OF MERCURY VAPOR STREET LIGHTS

Mercury Vapor street lighting service has been restricted in JCP&L's Tariff since July 1982. Sodium Vapor fixtures were considered standard at that time due to their superior energy efficiency. The Tariff provided for the Company to maintain all the existing Mercury Vapor streetlights, but new Mercury Vapor fixtures would not be installed after that date.

The Energy Policy Act of 2005 (42 USC §13201 et seq.) bans the manufacture or import of Mercury Vapor ballasts after January 1, 2008. This Act does NOT prohibit the continued maintenance of Mercury Vapor fixtures beyond this date – as long as inventory remains. Once inventory has been depleted however, any Mercury Vapor fixtures that require new ballasts will need to be replaced with Sodium Vapor fixtures.

Please refer to the table on page 5, under “**Upgrading Existing Street Lights,**” which shows the Mercury Vapor and Sodium Vapor lamp wattage options. Since Sodium Vapor fixtures are more energy efficient than Mercury Vapor, a smaller lamp size may provide equal or greater lumen output per kilowatt-hour of electricity, resulting in a net savings in the monthly energy cost. The current difference in cost is shown in the same table on page 5.

OUTDOOR LIGHTING SERVICE (FLOODLIGHTS AND AREA LIGHTS)

Outdoor Lighting Service consists of High-Pressure Sodium (HPS) Area Lights and Sodium Vapor (SV) Floodlights. Outdoor Lighting Service is not available for the illumination of public streets and highways. This service is provided from “dusk to dawn” with operation controlled by a photoelectric cell; timers are not available for shorter periods of operation. The Company will only install HPS area lights or SV floodlights on existing wood distribution poles where secondary facilities are located along existing Company rights-of-way. The Company will not install new poles for Outdoor Lighting Service on private property nor will the Company install HPS area lights or SV floodlights on buildings.

STREET LIGHTING SERVICE OPTIONS

JCP&L offers three service options for **SVL** Street Lighting Service, with three corresponding monthly rates. The three service options are categorized as **Company Fixtures**, **Contribution Fixtures**, and **Customer Fixtures**.

Company Fixtures

Company Fixtures refer to all street lighting equipment including brackets and luminaires installed by the Company at its expense in accordance with its standard specifications, and all other equipment necessary in rendering the required Service installed on wood distribution poles or Street Light Poles. Company Fixtures shall be owned, operated, maintained and serviced by the Company.

Contribution Fixtures

Contribution Fixtures refer to Company Fixtures for which installation the customer has paid the following Contributed Installation Cost. Contribution Fixtures shall be owned, operated, maintained and serviced by the Company. **Contributed Installation Cost:** The Contributed Installation Cost, per fixture, shall be equal to the cost shown on Tariff Part II, Appendix A – Exhibit III, for Street Light Luminaire.

Customer Fixtures

Customer fixtures refer to all customer-provided and installed street lighting equipment, including brackets, luminaires, and wire required for connection by the Company to a designated point on the Company's existing distribution facilities. Such fixtures must be contiguous and installed on customer provided and installed poles located in areas that allow them to be clearly discernable from non-customer-owned street light facilities. Customer fixtures and poles must be installed in accordance with the current edition of the National Electrical Code, as well as equipment standards established and approved by the Company. Any necessary maintenance, repairs, or replacements to Customer Fixtures or poles, including lamp and control switch replacements, or luminaire cleaning, shall be made by the Customer.

Engineering Study Fee

Depending on the scope of Customer/Applicant requested streetlight project, JCP&L may require an Engineering Study Fee from the project requester, before initiating and proceeding with the project.

APPLICATION PROCEDURE FOR STREET LIGHTING

Installation of New Street Lights

Underground Residential Subdivision:

The installation of new streetlights can only be authorized by a Municipality, since the Municipality is ultimately responsible for paying the monthly street lighting bills. When a Municipality requires the installation of new streetlights in an Underground Residential Subdivision (URD), the developer must obtain Municipal approval for the proposed lighting layout and provide the Company with initial information concerning the Municipality's street light requirements for a given subdivision.

If the Municipality desires a fixture style other than the standards offered by JCP&L, the Company will furnish metered or unmetered (in extraordinary circumstances) connection points for the installation of Customer Fixtures (refer to page 3.)

JCP&L will install streetlights in a URD Subdivision as part of the installation of electrical distribution facilities only after the developer has obtained approval of the street lighting layout from the Municipality, and after the developer has executed all necessary contracts/agreements and paid all required costs pursuant to JCP&L's Tariff.

Individual Street Light Requests:

When a Municipality desires to have new streetlight installed or existing streetlight(s) upgraded or converted to LED(s) in an area other than a new URD Subdivision, please use the **Street Light Request Form**. The form can be emailed to you by your Regional External Affairs Consultant (refer to pages 28 & 29) or contact the JCP&L Customer Service Center at 1-800-662-3115 to initiate your request. **Please note: The following information is needed.**

- Name of Municipality
- SVL or **LED** Street lighting Account number
- Type of lighting desired (overhead or underground service)
- Style/Fixture Type (Cobra, Ornate, Colonial, etc.)
- Bracket Size - See Page 8
- Locations (House numbers, street names, lot/block numbers)
- Pole number
- Billing Rate (Company (SVL, LED) or Contribution Fixture SVL, LED)
- Lamp Wattage (based on availability for light style)

The Regional External Affairs Consultant will initiate a telememo and forward the work request and the Street Light Request Form to an appropriate Company representative who will create a Notification. The Notification will be assigned to a Layout Technician who may contact the requestor and the Regional External Affairs Consultant to obtain further details. The Layout Technician will prepare the work package along with any costs associated with the requested installation/removal. Upon receiving the necessary payments, permits, etc., the street light work order will be released to be scheduled.

Upgrading Existing Street Lights

TERM OF CONTRACT- The contract term of the Street light Contract for the installation of SVL Company Fixtures will be five (5) years and for LED Company Fixtures will be fifteen years (15), and in each case, on a monthly basis after the expiration of the term. If street light service is terminated before the end of the contract term, the Municipality will be billed the total of each light's monthly fixture charge, plus the KWH Distribution Charge applicable to each light's billing month KWH, times the remaining months of the contract term.

Street light upgrades can be classified into three categories:

- (1) An increase in lamp wattage, subject to the limitations of the luminaire style
- (2) Conversion of an existing light type to another type
- (3) Conversion of standard fixtures to ornate fixtures

To request an increase in lamp wattage for an existing streetlight, the Municipality may contact the Customer Service Center at **1-800-662-3115** to initiate the process. The Municipality must furnish the location of the streetlights to be upgraded, preferably with a street address and the Company's pole number, which can be found on the pole. Refer to the Street Lighting Options section of this Handbook to determine the maximum wattage for each fixture style that the Company offers. The assigned Layout Technician may contact the requestor for additional information. The Layout Technician will prepare the work package along with any costs associated with the upgrade. Upon receiving payment, the street light upgrade work order will be scheduled.

Conversions of Mercury Vapor (MVL) or Incandescent streetlights (ISL) to LED streetlights or Sodium Vapor (SVL) shall be scheduled in accordance with the Company's Streetlight Conversion Program. The Company may limit the number of conversions to no more than 5% of the lamps served under this service classification (*i.e.*, SVL) at the end of the previous year. LED and SVL lamps are more energy efficient and may provide greater light output per kilowatt-hour of electricity resulting in a net savings in the monthly energy cost. The difference in monthly charges is shown in the same table below for MVL and page 6 for ISL. (See chart on page 34 for additional information)

The monthly charges being compared in the following two tables are "Company Fixture" charges for Summer months, June through September. The Lumen values for LED streetlights are those for Cobra Head with 3000 Kelvin Temperature, which is Warm White color. (Refer to page 21 for LED Street Lighting details)

		MERCURY VAPOR, LED, SODIUM VAPOR					
		Wattage, Lumens & Cost					
Wattage & Lamp Type	Delivered* Lumens	SUMMER Monthly Cost (\$)	Wattage & Lamp Type	Delivered* Lumens	SUMMER Monthly Cost (\$)	Cost Difference	
100 W MVL	2,800	\$ 9.97	30 W LED	3,900	\$ 7.90	-\$2.07	
175 W MVL	5,390	\$14.11	90 W LED	9,000	\$11.10	-\$3.01	
250 W MVL	8,400	\$17.87	90 W LED	9,000	\$11.10	-\$6.77	
400 W MVL	15,750	\$26.16	260 W LED	27,800	\$21.84	-\$4.32	
100 W MVL	2,800	\$ 9.97	50 W SVL	2,800	\$ 9.20	-\$0.77	
175 W MVL	5,390	\$14.11	100 W SVL	6,650	\$11.93	-\$2.18	
250 W MVL	8,400	\$17.87	150 W SVL	11,200	\$ 14.52	-\$3.35	
400 W MVL	15,750	\$26.16	250 W SVL	19,250	\$ 21.02	-\$5.14	
700 W MVL	28,000	\$42.37	400 W SVL	35,000	\$30.23	-\$ 12.14	

*Delivered Lumens provided for comparison purposes between LED, MVL and SVL Cobra Head type Fixtures. LED Lumen Values listed are representative of GE manufactured fixtures. MVL and SVL lumen values at 70% of source lumens due to loss of trapped lumens.

 <small>A FirstEnergy Company</small>	INCANDESCENT, LED, SODIUM VAPOR Wattage, Lumens & Cost						Cost Difference
	Wattage & Lamp Type	Source Lumens	SUMMER Monthly Cost (\$)	Wattage & Lamp Type	Delivered* Lumens	SUMMER Monthly Cost (\$)	
105 W ISL	1,000	\$ 6.71	30 W LED	3,900	\$ 7.90	\$1.19	
205 W ISL	2,500	\$ 11.25	30 W LED	3,900	\$ 7.90	-\$3.35	
327 W ISL	4,000	\$16.69	50 W LED	5,300	\$ 8.76	-\$7.93	
448 W ISL	6,000	\$22.27	90 W LED	9,000	\$11.10	-\$11.17	
105 W ISL	1,000	\$ 6.71	50 W SVL	2,800	\$ 9.20	\$2.49	
205 W ISL	2,500	\$ 11.25	50 W SVL	2,800	\$ 9.20	-\$2.05	
327 W ISL	4,000	\$16.69	70 W SVL	4,410	\$10.37	-\$6.32	
448 W ISL	6,000	\$22.27	100 W SVL	6,650	\$11.93	-\$10.34	

**Delivered Lumens provided for comparison purposes between LED, MVL and SVL Cobra Head type Fixtures. LED Lumen Values listed are representative of GE manufactured fixtures. MVL and SVL lumen values at 70% of source lumens due to loss of trapped lumens. (See chart on page 34 for additional information) (Refer to page 20 for LED Street Lighting details)*

Trapped Lumen Reference, provided by GE, for High Intensity Discharge (HID) bulbs such as MVL and SVL - "The 'trapped lumens' of HID are due to the fact that HID lamps are round/tubular and there is an unexposed 'back-side' that allows for the light to bounce around inside the optical compartment and in many cases, return through the lamp and therefore get blocked or trapped where this light is not utilized. LED is simply a single-sided light source where the light is emitted out in a single direction or from a single side of its 'housing'. As such, the above shortcoming of the old technologies does not exist for LED's."

Any Municipality that would like to initiate the Sodium Vapor Lighting (SVL) Conversion Program must contact the Company's Customer Service Center at **1-800-662-3115**. There will be NO labor charge for this type of conversion due to obsolescence, although as mentioned earlier, the Company may limit the number of conversions to no more than 5% of the lamps served under this service classification (SVL) at the end of the previous year.

Also, if the Company must replace a Mercury Vapor (MV) or Incandescent luminaire (ISL) (*i.e.*, the fixture, not the bulb) due to failure or damage, it will be replaced with a SVL luminaire sized according to the chart shown above and on page 5. The associated accounts will be adjusted to reflect the change in billing.

A Municipality interested in replacing existing Standard Overhead Street lights (Cobra Heads) to Ornate overhead fixtures may contact the Company's Customer Service Center at **1-800-662-3115** to initiate the request. This type of change will involve billing for the removal of the existing fixtures and installation of the Ornate fixtures, plus additional charges for removal of any lights that have been installed less than five years. Ornate overhead fixtures are installed with a 2.5' bracket located 15' above ground (see pages 11 & 12). Therefore, in order to maintain the same level of illumination, additional fixtures may be required.

REMOVAL OF EXISTING STREET LIGHTS

When a Municipality desires to have certain streetlights taken out of operation, it must contact the Company's Customer Service Center at **1-800-662-3115**. It will be necessary to provide the location of the streetlights, including street address and Company pole number. The streetlight is left in place, but the photoelectric cell is removed to prevent the light from operating.

Should the Municipality desire to have a fixture physically removed, there will be billing charges for the associated labor. If the **Term of Contract** has NOT been satisfied, there will be additional charges involved for early termination as described under "**Term of Contract**" on page 5 for **SVL** and page 20 for **LED** luminaires.

STREET LIGHTING OPTIONS – OVERHEAD

Street Light Option 1:

The Company will install NEW SVL Cobra Head luminaires on a standard 8' bracket as shown on pages 10 for SVL on existing wood distribution "**fixture poles**", without installation charge, when such facilities are requested by a Municipality.

Street Light Option 2:

The Company offers a gray or black SVL Colonial Post Top luminaire shown on page 11 and a black SVL Ornate Colonial shown on page 12 for installation on "**fixture poles**" with a 2' or 2.5' bracket respectively. The prices shown for these lights are for new installations only where there are no existing streetlights. **This Street Light Option is not available for LED Lights.**

If a new wood distribution "**fixture pole**" is needed along a public right-of-way in order to install a SVL streetlight, the Company will install the pole, standard 8' bracket, one span of street light wire without charge to the Municipality.

"**Span poles**" which are installed to carry wire to "**fixture poles**", shall be installed with the associated wire only upon payment of a non-refundable contribution.

MVL, ISL, SVL - *The Municipality will be responsible for providing and paying the costs of all traffic control including police assistance where and when needed. If the Municipality is unable to provide the required traffic control, the Company will provide the traffic control with the Municipality paying all associated costs. The Municipality will also be responsible for all fees associated with required permitting.*

LED Lighting - *The Municipality will be responsible for providing and paying the costs of police assistance when deemed necessary by local authorities. The Company will provide basic traffic control (flaggers) at no cost to the Municipality. When traffic control (flagging) labor hours exceed construction labor hours (considered non-basic traffic control) the Municipality will be responsible for paying the differential in costs between basic and non-basic traffic control. The Municipality will also be responsible for all fees associated with required permitting.*

LIGHTING BRACKETS- OVERHEAD

Bracket Mounting Heights

Aluminum- CNJ

Galvanized- NNJ

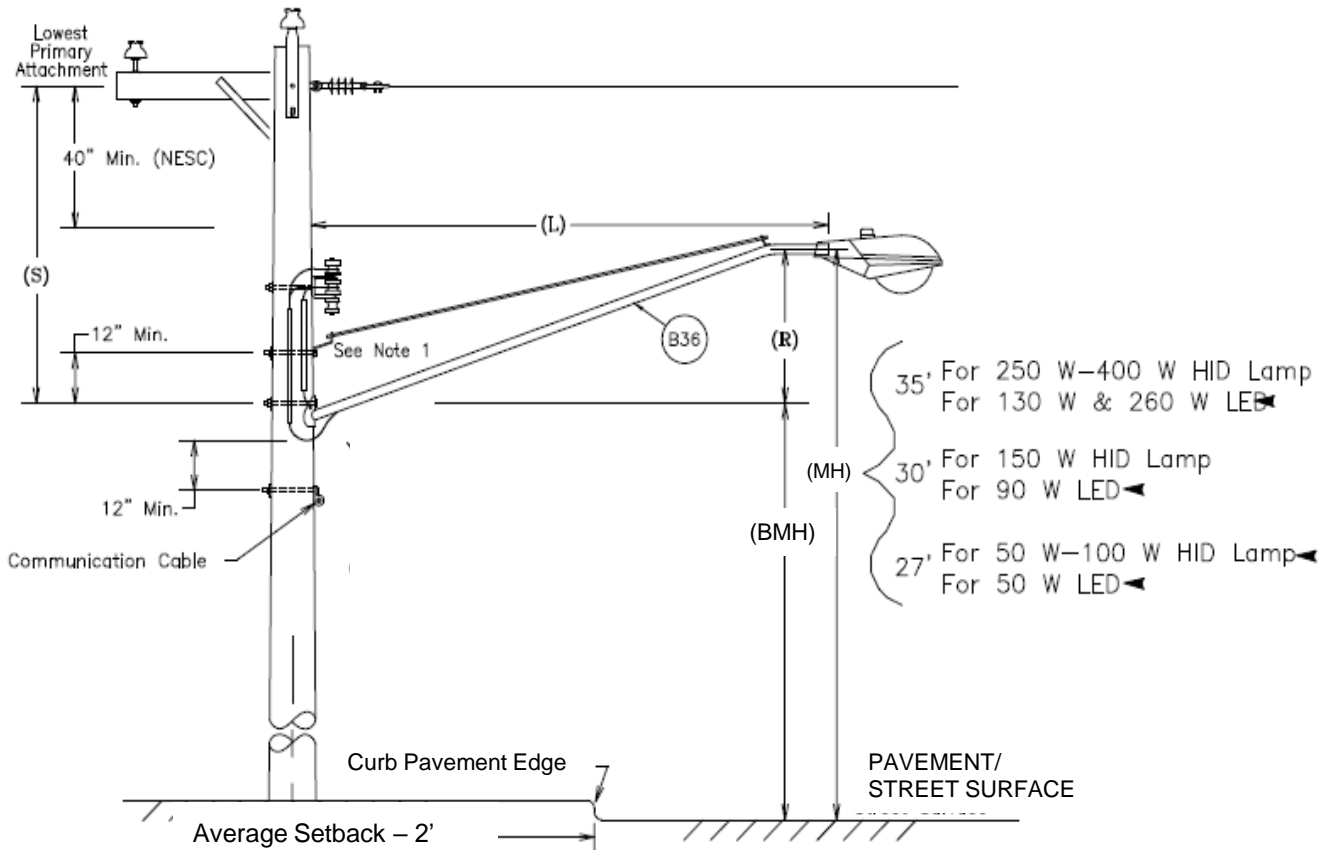

Nominal Bracket Length (L) Aluminum/Galv	Distance from Pole to Center of Light	BRACKET MOUNTING HEIGHT (BMH)		
		70W-100W SVL 50W LED	150W SVL 90W LED	250W-400W SVL 130W-260W LED
2.0/2.5'	2.0/2.5'	25.5'	28.5'	33.5'
4'	5.5'	25.33'	28.35'	33.33'
6'	7.5'	25.0'	28.0'	33.0'
8'	9.5'	24.5'	27.5'	32.5'
12' / 12'	13.5'	23.5'	26.5'	31.5'
15'	16.5'	23.5'	26.5'	31.5'
16'	16.5'	22.5'	25.5'	30.5'
20' / 20'	21.5'	21.5'	24.5'	29.5'

STANDARD COBRA HEAD - SVL

Available Lamp sizes:

50, 70, 100, 150, 250 and 400 - watt Sodium Vapor

- ❖ Standard Cobra Head (semi-cutoff)

50 watt is IES Type II;

70 - 400 watts are IES Type III

- ❖ Low Profile Cobra Head (cutoff):

70 - 150 watts are IES Type II

250 & 400 watts are IES Type III

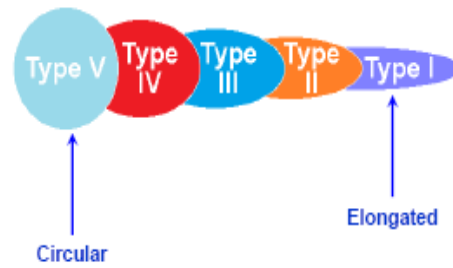

- ❖ Refractors: All lamp sizes are available with Standard (semi-cutoff) optic refractors. Low Profile (cutoff) optic refractors are available for 70 watt through 400 - watt lamp sizes.



STANDARD
DROP PRISMATIC
REFRACTOR



CUTOFF
OPTICS



SAG LENS
(LOW PROFILE)

- ❖ Street light luminaires shall be installed on a standard 8' bracket. A longer bracket may be required depending on, among other things, the width of the roadway. The chart on page 8 shows the typical support bracket lengths available. Brackets longer than the standard bracket are subject to additional charges.

- ❖ See page 30 for Manufactures website and phot metrics.

- ❖ See page 21 for LED Lighting Options.

1. STANDARD COBRA HEAD - SVL ON A WOOD POLE WITH AN 8' BRACKET

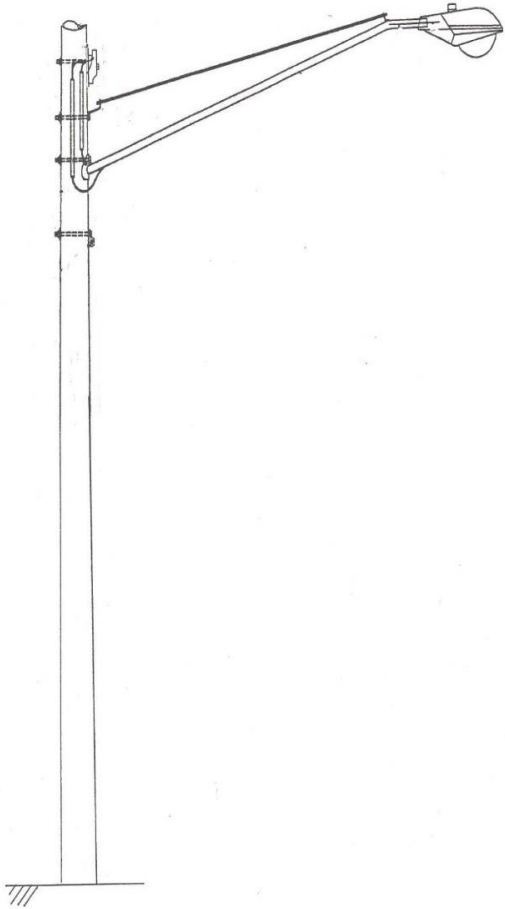

- ❖ Available for overhead service.
- ❖ Available sizes: Sodium Vapor: 50, 70, 100, 150, 250 & 400 watt
- ❖ There is no installation cost for a NEW overhead SVL fixture on a wood pole with a standard 8' bracket.
- ❖ Additional fees may apply for brackets larger than 8'.
- ❖ See table below for Company and Contribution fixture rates. Contribution Fixtures require a one-time payment of \$665.78 per fixture.
- ❖ Refer to the Company's Tariff & chart on page 34 for additional details.
- ❖ See page 21 for LED Lighting Option.

		STANDARD COBRA HEAD SODIUM VAPOR LUMINAIRE			
LAMP SIZE		MONTHLY RATE			
WATTS	IES TYPE	COMPANY FIXTURE		CONTRIBUTION FIXTURE	
		Jun – Sep	Oct – May	Jun – Sep	Oct – May
50	II MSCO	\$ 9.20	\$ 9.23	\$ 4.54	\$ 4.57
70	III MSCO	\$ 10.37	\$ 10.41	\$ 5.71	\$ 5.75
100	III MSCO	\$ 11.93	\$ 11.98	\$ 7.27	\$ 7.32
150	III MSCO	\$ 14.52	\$ 14.60	\$ 9.86	\$ 9.94
250	III MSCO	\$ 21.02	\$ 21.16	\$ 15.17	\$ 15.31
400	III MSCO	\$ 30.23	\$ 30.46	\$ 24.38	\$ 24.61

2. COLONIAL STANDARD SIDE-MOUNTED – SVL

WITH 2' ALUMINUM BRACKETS ON WOOD POLE

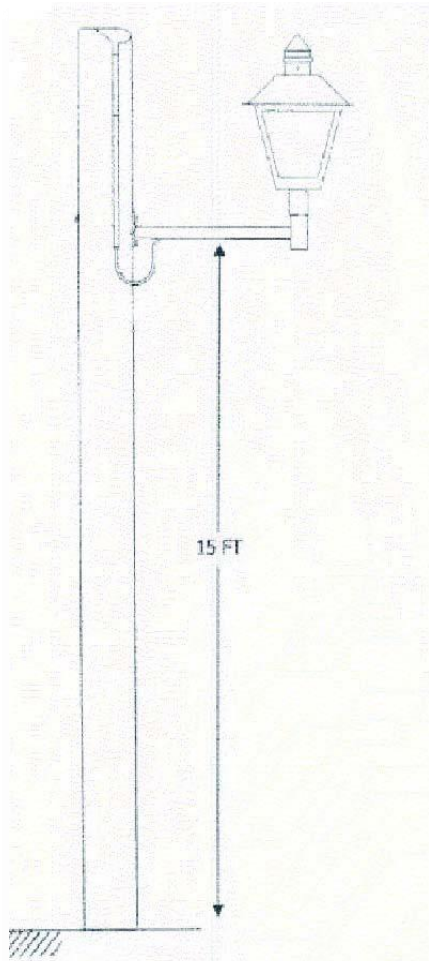

- ❖ Available for overhead service.
- ❖ Available sizes Sodium Vapor Lights: 50, 70, 100 & 150 watt.
- ❖ Available in Gray only on standard bracket shown.
- ❖ There is no installation cost for a NEW overhead SVL Colonial fixture installed on a wood pole with a standard bracket.
- ❖ See table below for Company and Contribution fixture rates. Contribution Fixtures require a one-time payment of \$665.78 per fixture.
- ❖ Refer to the Company's Tariff for additional billing details.
- ❖ Not Available in LED.

		COLONIAL STANDARD SODIUM VAPOR LUMINAIRE SIDE-MOUNTED			
LAMP SIZE		MONTHLY RATE			
WATTS	IES TYPE	COMPANY FIXTURE		CONTRIBUTION FIXTURE	
		Jun -Sep	Oct -May	Jun -Sep	Oct -May
50	MS III	\$ 9.20	\$ 9.23	\$ 4.54	\$ 4.57
70	MS III & V	\$ 10.37	\$ 10.41	\$ 5.71	\$ 5.75
100	MS III & V	\$ 11.93	\$ 11.98	\$ 7.27	\$ 7.32
150	MS III	\$ 14.52	\$ 14.60	\$ 9.86	\$ 9.94

3. ORNATE COLONIAL SIDE-MOUNTED - SVL

WITH 2.5' ALUMINUM BRACKET ON WOOD POLE

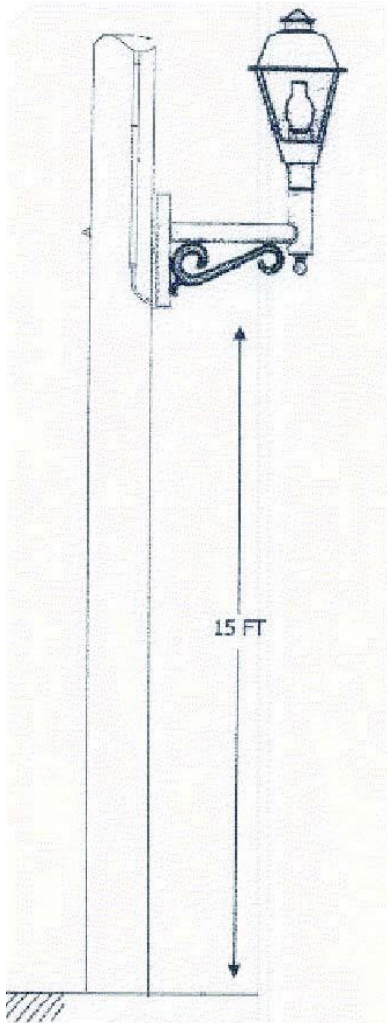

- ❖ Available for overhead service.
- ❖ Only available sizes Sodium Vapor Light: 70 & 100 watt
- ❖ Available in Black Only.
- ❖ Installation cost: \$517.79 per fixture.
- ❖ See table below for Company and Contribution fixture rates. Contribution Fixtures require a one-time payment of \$665.78 per fixture.
- ❖ Refer to the Company's Tariff for additional billing details.
- ❖ Not Available in LED.

Jersey Central Power & Light <small>A FirstEnergy Company</small>		ORNATE COLONIAL LUMINAIRE SIDE-MOUNTED			
LAMP SIZE		MONTHLY RATE			
WATTS	IES TYPE	COMPANY FIXTURE		CONTRIBUTION FIXTURE	
		Jun -Sep	Oct -May	Jun -Sep	Oct -May
70	MS III & V	\$ 10.37	\$ 10.41	\$ 5.71	\$ 5.75
100	MS III & V	\$ 11.93	\$ 11.98	\$ 7.27	\$ 7.32

STREET LIGHTING OPTIONS - UNDERGROUND

Underground service for streetlights is furnished by the Company in new Underground Residential Subdivisions (URD) consisting of three or more building lots, or in conventional underground secondary networks found in more urban areas of the Company's service territory. Conventional underground networks can be found in portions of Asbury Park, Belmar, Bradley Beach, Deal, Freehold Borough, Harding Township, Lakewood, Long Branch, Monmouth Beach, Morristown, Neptune, Point Pleasant Beach, Pompton Lakes, Red Bank, Rumson, Spring Lake, and Summit.

The standard Lighting Option offered by the Company for installation in URDs is the Colonial Post Top Luminaire on a 16' fiberglass pole. This standard is an economical choice and is available in gray or black in Sodium Vapor or black in LED. There are several additional Ornate options available in Sodium Vapor only, including an Ornate Colonial Post Top with two post choices. An Acorn Style Post Top Luminaire is available in SVL or LED in Black on a 12' 9" post.

There is one additional lighting choice for underground residential subdivisions, which consists of a Cobra Head luminaire with a 6' bracket, mounted on a 30' gray fiberglass pole available in both SVL and LED. This type of installation allows for greater separation between lights due to the increased mounting height.

The installation costs shown on the following pages for the various underground street light fixtures **are only applicable for new installations within URD's made at the time of initial construction.** The cost to retrofit additional streetlights within a URD Subdivision subsequent to initial construction will be subject to additional charges. These charges may include certain preparation fees, traffic control costs (if not provided by the Municipality), permit fees, etc.

The SVL or LED Cobra Head luminaire shown on an aluminum/steel pole is typically only installed in conventional underground network areas. The pole is available in two heights, with a 6' standard mounting bracket. There is no charge to the Municipality for this type of installation in a conventional underground network area, provided there are no existing streetlights that would need to be removed (see page 7 regarding removal costs).

Please note that the installation costs shown on the following pages for the various underground fixtures are greater than the values found in Appendix A, Part II of the Company's Tariff. The difference is because the costs shown herein reflect the inclusion of the CIAC Tax Gross-up which the Company must pay Federal and State Income Taxes on all Contribution-in-Aid-of-Construction, in accordance with Section 3.14, Part II of the Tariff.

1. COLONIAL POST TOP - SVL

WITH 16' FIBERGLASS POLE



- ❖ Available for underground service.
- ❖ Available sizes Sodium Vapor:
50, 70 100 & 150 watt
- ❖ Smooth surface or textured in gray and black.
- ❖ Installation cost: \$420.88 per fixture.
- ❖ See table below for Company and Contribution fixture rates. Contribution Fixtures require a one-time payment of \$665.78 per fixture.
- ❖ Refer to the Company's Tariff for additional billing details.
- ❖ See page 23 for LED Lighting Option in Black only.

 A FirstEnergy Company		COLONIAL POST TOP STANDARD LUMINAIRE SODIUM VAPOR LIGHT			
LAMP SIZE		MONTHLY RATE			
WATTS	IES TYPE	COMPANY RATE		CONTRIBUTION RATE	
		Jun -Sep	Oct -May	Jun -Sep	Oct -May
50	MS III	\$ 9.20	\$ 9.23	\$ 4.54	\$ 4.57
70	MS III & V	\$ 10.37	\$ 10.41	\$ 5.71	\$ 5.75
100	MS III & V	\$ 11.93	\$ 11.98	\$ 7.27	\$ 7.32
150	MS III	\$ 14.52	\$ 14.60	\$ 9.86	\$ 9.94

2. ORNATE COLONIAL POST TOP-1 SVL

WITH 16' FIBERGLASS POLE

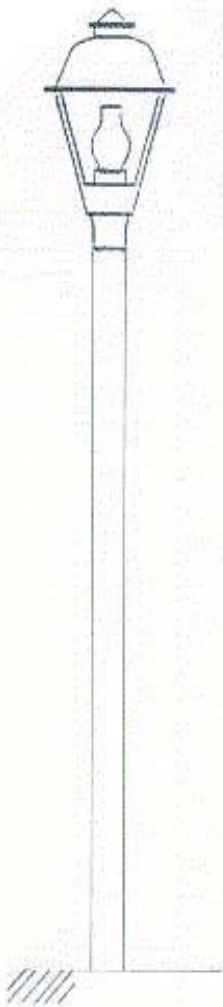

- ❖ Available for underground service.
- ❖ Available sizes in Sodium Vapor:
70 & 100 watt in black only
- ❖ Installation cost: \$1,183.08 per fixture
- ❖ See table below for Company and Contribution fixture rates. Contribution Fixtures require a one-time payment of \$665.78 per fixture.
- ❖ Refer to the Company's Tariff for additional billing details.
- ❖ NOT available in LED.

 Jersey Central Power & Light <i>A FirstEnergy Company</i>		ORNATE COLONIAL POST TOP SODIUM VAPOR LUMINAIRE-I			
LAMP SIZE		MONTHLY RATE			
WATTS	IES TYPE	COMPANY RATE		CONTRIBUTION RATE	
		Jun -Sep	Oct -May	Jun -Sep	Oct -May
70	MS III & V	\$ 10.37	\$ 10.41	\$ 5.71	\$ 5.75
100	MS III & V	\$ 11.93	\$ 11.98	\$ 7.27	\$ 7.32

3. ORNATE COLONIAL POST TOP-II SVL

WITH 12' 9" ORNATE FIBERGLASS POLE

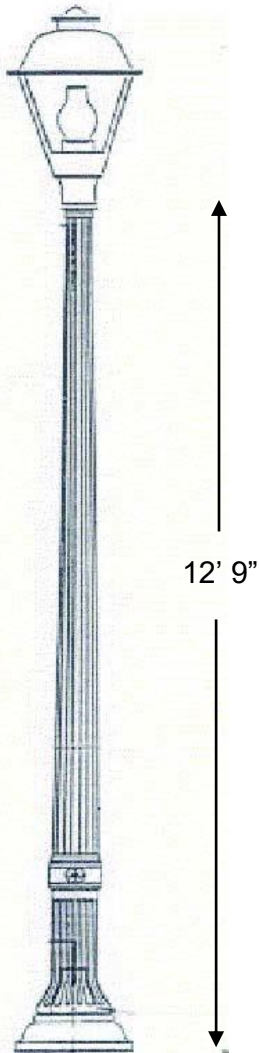

- ❖ Available for underground service.
- ❖ Available sizes in Sodium Vapor 70 & 100 watt in black only.
- ❖ Installation cost \$2,960.01 per fixture.
- ❖ See table below for Company and Contribution fixture rates. Contribution Fixtures require a one-time payment of \$665.78 per fixture.
- ❖ Refer to the Company's Tariff for additional billing details.
- ❖ NOT available in LED.

(Installed on JCP&L screw base)

 <i>A FirstEnergy Company</i>		ORNATE COLONIAL POST TOP SODIUM VAPOR LUMINAIRE- II			
LAMP SIZE		MONTHLY RATE			
WATTS	IES TYPE	COMPANY RATE		CONTRIBUTION RATE	
		Jun -Sep	Oct -May	Jun -Sep	Oct -May
70	MS III & V	\$ 10.37	\$ 10.41	\$ 5.71	\$ 5.75
100	MS III & V	\$ 11.93	\$ 11.98	\$ 7.27	\$ 7.32

4. ORNATE ACORN STYLE POST TOP - SVL

WITH 12' 9" ORNATE FIBERGLASS POLE

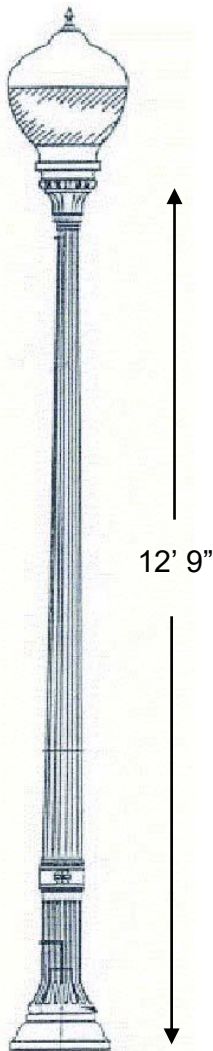

(Installed on JCP&L screw base)

- ❖ Available for underground service.
- ❖ Available sizes in Sodium Vapor:
70 & 100 watt in black only
- ❖ Installation cost: \$3,729.13 per fixture.
- ❖ See table below for Company and Contribution fixture rates. Contribution Fixtures require a one-time payment of \$665.78 per fixture.
- ❖ Refer to the Company's Tariff for additional billing details.
- ❖ See page 24 for LED Lighting Option.

 A FirstEnergy Company		ORNATE ACORN STYLE POST TOP SODIUM VAPOR LUMINAIRE			
LAMP SIZE		MONTHLY RATE			
WATTS	IES TYPE	COMPANY RATE		CONTRIBUTION RATE	
		Jun -Sep	Oct -May	Jun -Sep	Oct -May
70	MS III & V	\$ 10.37	\$ 10.41	\$ 5.71	\$ 5.75
100	MS III & V	\$ 11.93	\$ 11.98	\$ 7.27	\$ 7.32

5. COBRA HEAD – 6’ BRACKET - SVL

WITH 30’ FIBERGLASS POLE

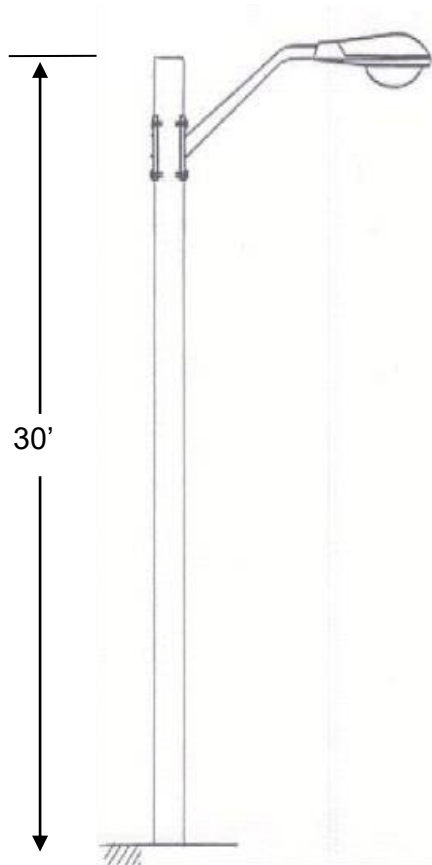

- ❖ Available for underground service.
- ❖ Available sizes in Sodium Vapor: 70, 100, 150, 250 & 400 watt in gray only.
- ❖ Fiberglass pole cost \$1,298.39 per fixture.
- ❖ See table below for Company and Contribution fixture rates. Contribution Fixtures require a one-time payment of \$665.78 per fixture.
- ❖ Refer to the Company’s Tariff & chart on page 34 for additional details.
- ❖ See page 25 for LED Lighting Option.

		COBRA HEAD SODIUM VAPOR LUMINAIRE 6’ BRACKET			
LAMP SIZE		MONTHLY RATE			
WATTS	IES TYPE	COMPANY RATE		CONTRIBUTION RATE	
		Jun - Sep	Oct - May	Jun – Sep	Oct - May
70	III MSCO	\$ 10.37	\$ 10.41	\$ 5.71	\$ 5.75
100	III MSCO	\$ 11.93	\$ 11.98	\$ 7.27	\$ 7.32
150	III MSCO	\$ 14.52	\$ 14.60	\$ 9.86	\$ 9.94
250	III MSCO	\$ 21.02	\$ 21.16	\$ 15.17	\$ 15.31
400	III MSCO	\$ 30.23	\$ 30.46	\$ 24.38	\$ 24.61

6. COBRA HEAD ON ALUMINUM POLE- SVL WITH 24' 8" OR 27' 2" POLE ON 20" TRANSFORMER BASE

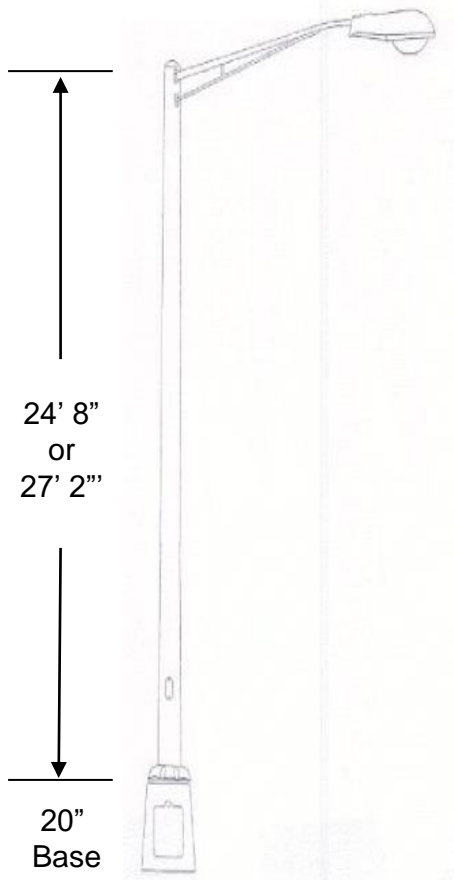

- ❖ Available for underground service.
- ❖ Pole available in natural aluminum finish only.
- ❖ Available sizes in Sodium Vapor: 50, 70, 100, 150, 250 & 400 watt.
- ❖ There is no installation cost for this fixture when used in an underground area served by a manhole/duct network.
- ❖ See table below for Company and Contribution fixture rates. Contribution Fixtures require a one-time payment of \$665.78 per fixture.
- ❖ Refer to the Company's Tariff & chart on page 34 for additional details.
- ❖ See LED Lighting Option on page 26.

Jersey Central Power & Light <small>A FirstEnergy Company</small>		COBRA SODIUM VAPOR LUMINAIRE ON ALUMINUM POLE			
LAMP SIZE		MONTHLY RATE			
WATTS	IES TYPE	COMPANY RATE		CONTRIBUTION RATE	
		Jun - Sep	Oct - May	Jun - Sep	Oct - May
50	II MSCO	\$ 9.20	\$ 9.23	\$ 4.54	\$ 4.57
70	III MSCO	\$ 10.37	\$ 10.41	\$ 5.71	\$ 5.75
100	III MSCO	\$ 11.93	\$ 11.98	\$ 7.27	\$ 7.32
150	III MSCO	\$ 14.52	\$ 14.60	\$ 9.86	\$ 9.94
250	III MSCO	\$ 21.02	\$ 21.16	\$ 15.17	\$ 15.31
400	III MSCO	\$ 30.23	\$ 30.46	\$ 24.38	\$ 24.61

LED STREET LIGHTING

TERM OF CONTRACT – Fifteen (15) years for each Company Fixture installation and thereafter on a monthly basis. Where special circumstances apply or special or unusual facilities are supplied, contracts of more than fifteen years may be required. Service that is terminated before the end of the contract term shall be billed the total of 1) each light's monthly Fixture Charge plus 2) the per KWH Distribution Charge applicable to each light's Billing Month KWH, times the remaining months of the contract term. (Removal costs are discussed on page 7). Restoration of Service to lamps before the end of the contract term shall be made at the expense of the customer. (Tariff Part III Sheet No. 39)

Where the installation of additional facilities, including, but not limited to; poles, wire, transformers, and brackets, is required to provide service to a fixture, Customers shall be responsible for payment of a Non-Refundable Contribution in Aid of Construction determined under Appendix A charges (see Tariff Part II) when applicable, or otherwise under billing work order costs estimates, which costs are subject to gross-up for applicable income taxes. Also, additional charges may apply under **Term of Contract** conditions for both **SVL** and **LED** lighting. Other fees may also apply such as: Highway Permits, Excess traffic control cost, certain preparation fees, etc. Please refer to the Original Sheet No. 37 – 40 of Part III of JCP&L's Tariff for more detail.

Service Classification LED (light-emitting diode) is available for installation of twelve (12) or more **LED** fixtures per request. **LED** streetlight is a solid-state light that uses a semi-conductor to convert electricity into light. KWH Charges are based on a standard illumination schedule of 4200 hours per year.

Scheduling LED Conversions: **LED** conversions of sodium vapor, mercury vapor or incandescent streetlights shall be scheduled at the **Company's reasonable discretion**. (Refer also to chart on pages 5-6 for applicable Wattage, Lumens, Cost and cost differential details).

*JCP&L will **NOT** install decorative underground lighting for streetscape projects, Municipal parking lots, driveways, walkways, or Park & Ride facilities. JCP&L will only install streetlights along public right-of-way for the illumination of roadways. (For existing JCP&L owned street lighting in areas other than along Public Roadways, lighting may be converted to LED Luminaires. (Does not apply to Floodlights or Outdoor Area Lights).*

LED LIGHTING OPTIONS

Option 1- LED Overhead Cobra:

The Company will install a NEW LED Cobra Head Luminaire with a standard 8’ bracket on a wood distribution “fixture pole” (see pg. 7) in overhead area, with charges, when such facilities are requested by a Municipality* for 12 or more lights per request.

Option 2- Cobra Head on 30’ Fiberglass/Aluminum Post:



The Company will install a NEW LED Cobra Head Luminaire with a standard 8’ bracket in underground area, with charges, on a 30’ Fiberglass post or on an Aluminum pole located within a Network Duct system only, for 12 or more lights per request.

Option 3- LED Black Colonial Post Top:

The Company offers one style of LED Black Colonial Post Top luminaire on a 16’ Fiberglass post in underground area, with charges, for 12 or more lights per request.

Option 4- LED Black Acorn Post Top:

The Company offers one style of LED Black Post Top Acorn Luminaire on a 12’ 9’ Ornate Black Fiberglass post in underground area, with charges, for 12 or more lights per request.

	Cobra Head – LED				
	Wattage	IES Distribution	4000K Lumens	3000K Lumens	Mounting HT.
	30 W	TYPE III	4,000	3,900	See Page
	50 W	TYPE III	5,400	5,300	8
	90 W	TYPE III	9,200	9,000	for
	130 W	TYPE III	14,200	13,700	Mounting
	260 W	TYPE III	28,900	27,800	Heights
Gray only 120 -277 V & 480 V see page 22					
	Post Top Colonial - LED				
	Wattage	IES Distribution	4000K Lumens	3000K Lumens	Mounting HT.
	50 W	TYPE III	4,400	4,200	16’
	90 W	TYPE III	7,800	7,400	16’
	50 W	TYPE V	4,900	4,700	16’
	90 W	TYPE V	8,200	7,700	16’
Black only 120 – 277 V see page 23					
	Post Top Acorn – LED				
	Wattage	IES Distribution	4000K Lumens	3000K Lumens	Mounting HT.
	50 W	TYPE III	5,800	5,400	12’9”
	90 W	TYPE III	14,400	13,300	12’9”
	50 W	TYPE V	5,800	5,400	12’9”
	90 W	TYPE V	14,400	13,300	12’9”
Black only 120 - 277 V see page 24					

* The 4000K LED color is cool white and the 3000K LED color is warm white. LED Lumen Values listed are representative of GE manufactured fixtures.

1. STANDARD COBRA OVERHEAD - LED

ON WOOD POLE WITH A STANDARD 8' BRACKET (see pg. 8)

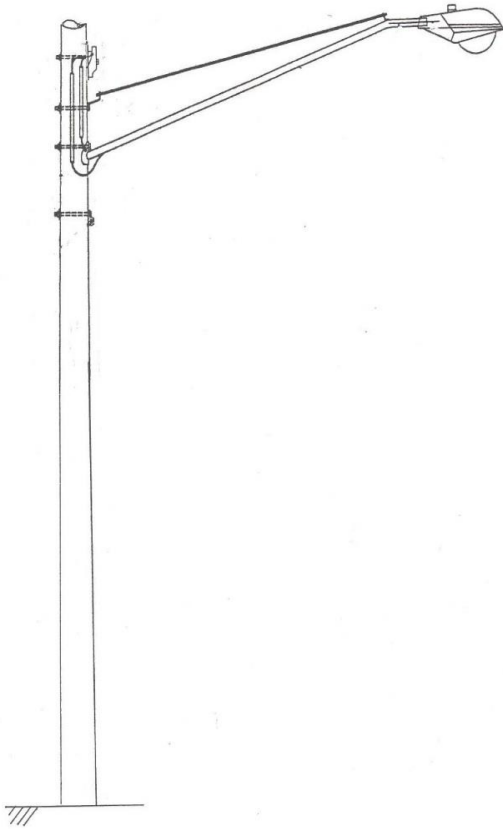

- ❖ Available in overhead service.
- ❖ Available sizes in LED: 30, 50, 90, 130, & 260 watt
- ❖ The installation cost for wood 'fixture pole' will be based on billing costs order estimates.
- ❖ Two Contribution Fixture options are available:

WATTS	(a)	(b)
30	\$358.38	\$209.20
50	\$354.88	\$205.70
90	\$403.55	\$254.37
130	\$492.97	\$343.79
260	\$694.22	\$545.04

- ❖ Refer to the Company's Tariff Part III, Original Sheet No. 37 – 39 for additional detail information.

			STANDARD COBRA - LED					
LAMP SIZE - IES TYPE III			MONTHLY RATE					
W	LUMENS		COMPANY RATE		CONTRIBUTION RATE (a)		CONTRIBUTION RATE (b)	
	4000K	3000K	Jun -Sep	Oct -May	Jun -Sep	Oct -May	Jun -Sep	Oct -May
30	4,000	3,900	\$7.90	\$7.91	\$4.08	\$4.09	\$5.67	\$5.68
50	5,400	5,300	\$8.76	\$8.79	\$4.98	\$5.01	\$6.57	\$6.60
90	9,200	9,000	\$11.10	\$11.14	\$6.80	\$6.84	\$8.39	\$8.43
130	14,200	13,700	\$13.86	\$13.92	\$8.61	\$8.67	\$10.20	\$10.26
260	28,900	27,800	\$21.84	\$21.96	\$14.45	\$14.57	\$16.04	\$16.16

LED Lumen Values listed are representative of GE manufactured fixtures.

2. POST TOP COLONIAL STYLE - LED

WITH 16' FIBERGLASS POLE

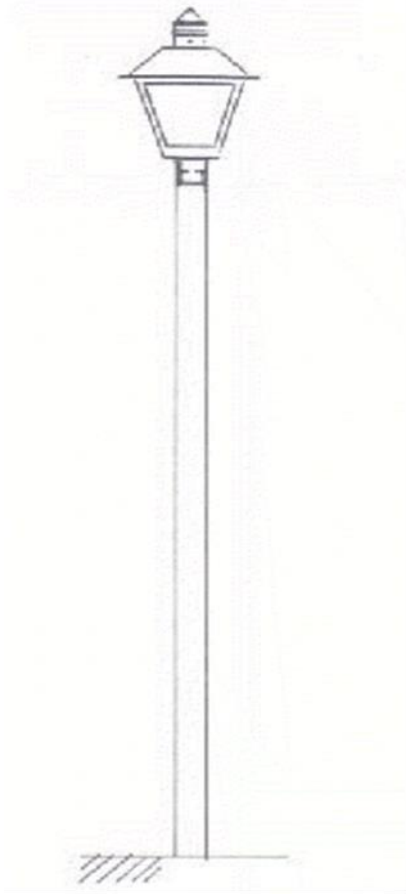

- ❖ Available in underground service.
- ❖ Available sizes in LED: 50 watt & 90 watt, black only.
- ❖ The installation cost for Post Top Colonial on 16' Fiberglass pole: \$665.34.
- ❖ Two Contribution Fixture options are available:

WATTS	(a)	(b)
50	\$619.38	\$470.20
90	\$793.88	\$644.70

- ❖ Refer to Company's Tariff, Part III, Original Sheet No. 37 -39 for additional detail information.

 A FirstEnergy Company			POST TOP COLONIAL - LED					
LAMP SIZE - IES TYPE III & V			MONTHLY RATE					
W	LUMENS		COMPANY RATE		CONTRIBUTION RATE (a)		CONTRIBUTION RATE (b)	
	IES TYPE III							
	4000K	3000K	Jun -Sep	Oct -May	Jun -Sep	Oct -May	Jun -Sep	Oct -May
50	4,400	4,200	\$ 11.57	\$ 11.60	\$ 4.98	\$ 5.01	\$ 6.57	\$ 6.60
90	7,800	7,400	\$15.26	\$15.30	\$ 6.80	\$ 6.84	\$ 8.39	\$ 8.43
IES TYPE V								
50	4,900	4,700	\$ 11.57	\$ 11.60	\$ 4.98	\$ 5.01	\$ 6.57	\$ 6.60
90	8,200	7,700	\$15.26	\$15.30	\$ 6.80	\$ 6.84	\$ 8.39	\$ 8.43

LED Lumen Values listed are representative of GE manufactured fixtures.

3. POST TOP ACORN STYLE - LED

WITH 12' 9" ORNATE FIBERGLASS POLE

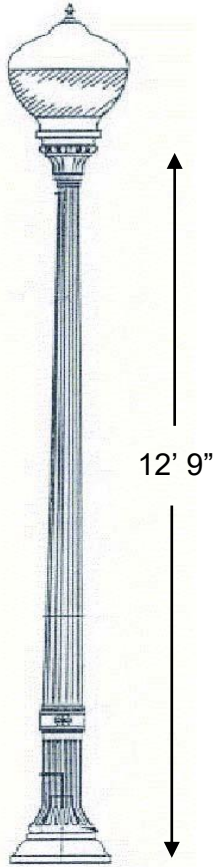

- ❖ Available for underground service.
- ❖ Available sizes in LED: 50 watt & 90 watt, in black only
- ❖ The installation cost for Decorative post: \$2,442.27.
- ❖ Two Contribution Fixture options are available:

WATTS	(a)	(b)
50	\$1,295.80	\$1,146.62
90	\$1,243.30	\$1,094.12

- ❖ Refer to the Company's Tariff, Part III, Original Sheet No. 37 - 39 for additional detail information.

(Installed on JCP&L screw base)

			POST TOP COLONIAL - LED					
LAMP SIZE - IES TYPE III & V			MONTHLY RATE					
W	LUMENS		COMPANY RATE		CONTRIBUTION RATE (a)		CONTRIBUTION RATE (b)	
	IES TYPE III		Jun -Sep	Oct -May	Jun -Sep	Oct -May	Jun -Sep	Oct -May
4000K	3000K							
50	5,800	5,400	\$ 18.79	\$ 18.82	\$ 4.98	\$ 5.01	\$ 6.57	\$ 6.60
90	14,400	13,300	\$ 20.05	\$ 20.09	\$ 6.80	\$ 6.84	\$ 8.39	\$ 8.43
IES TYPE V								
50	5,800	5,400	\$ 18.79	\$ 18.82	\$ 4.98	\$ 5.01	\$ 6.57	\$ 6.60
90	14,400	13,300	\$ 20.05	\$ 20.09	\$ 6.80	\$ 6.84	\$ 8.39	\$ 8.43

LED Lumen Values listed are representative of GE manufactured fixtures.

4. COBRA HEAD – 6’ BRACKET - LED WITH 30’ FIBERGLASS POLE

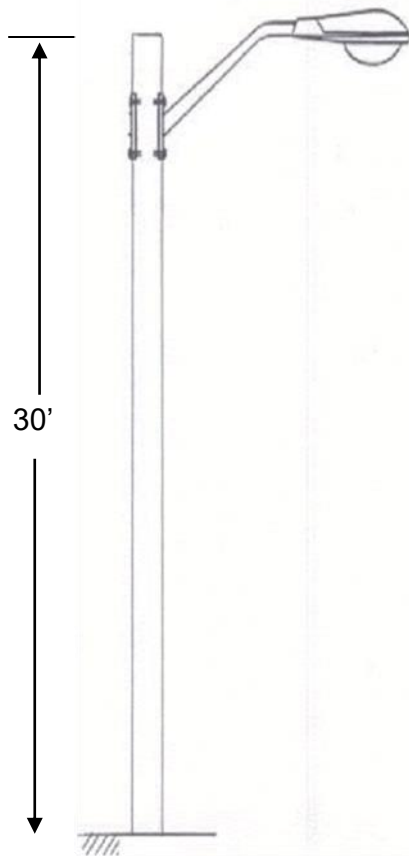

Available for underground service.

Available sizes in LED: 30, 50, 90, 130, and 260 watt, in gray only.

The installation cost for Fiberglass pole cost: \$1,342.21.

Two Contribution Fixture options are available:

WATTS	(a)	(b)
30	\$358.38	\$209.20
50	\$354.88	\$205.70
90	\$403.55	\$254.37
130	\$492.97	\$343.79
260	\$694.22	\$545.04

Refer to the Company’s Tariff, part III, Original Sheet No. 37 – 39 for additional detail information.

Jersey Central Power & Light <small>A FirstEnergy Company</small>			STANDARD COBRA - LED					
LAMP SIZE - IES TYPE III			MONTHLY RATE					
W	LUMENS		COMPANY RATE		CONTRIBUTION RATE (a)		CONTRIBUTION RATE (b)	
	4000K	3000K	Jun -Sep	Oct -May	Jun -Sep	Oct -May	Jun -Sep	Oct -May
30	4,000	3,900	\$7.90	\$ 7.91	\$ 4.08	\$ 4.09	\$ 5.67	\$ 5.68
50	5,400	5,300	\$ 8.76	\$ 8.79	\$ 4.98	\$ 5.01	\$ 6.57	\$ 6.60
90	9,200	9,000	\$11.10	\$11.14	\$ 6.80	\$ 6.84	\$ 8.39	\$ 8.43
130	14,200	13,700	\$13.86	\$13.92	\$ 8.61	\$ 8.67	\$ 10.20	\$ 10.26
260	28,900	27,800	\$21.84	\$21.96	\$14.45	\$14.57	\$16.04	\$16.16

LED Lumen Values listed are representative of GE manufactured fixtures.

5. COBRA HEAD ON ALUMINUM POLE - LED WITH 24' 8" OR 27' 2" POLE ON 20" TRANSFORMER BASE

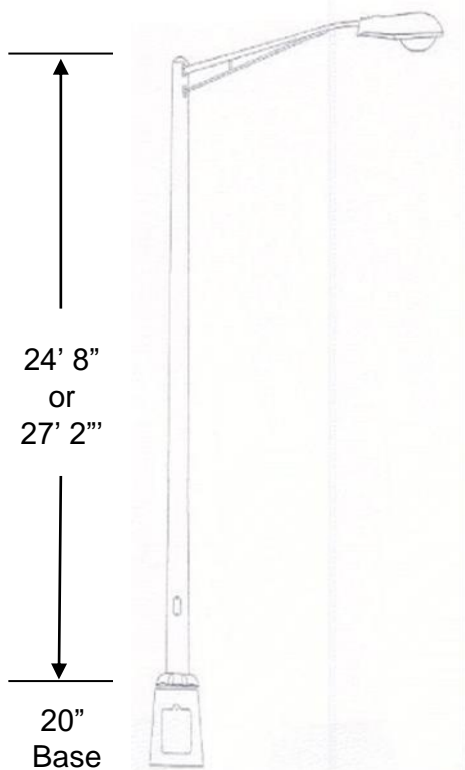

- ❖ Available for underground service. Pole available in natural aluminum finish only.
- ❖ Available sizes in LED: 30, 50, 90, 130 and 260 watt.
- ❖ The installation cost for Aluminum pole will be based on billing costs order estimates.
- ❖ Two Contribution Fixture options are available:

WATTS	(a)	(b)
30	\$358.38	\$209.20
50	\$354.88	\$205.70
90	\$403.55	\$254.37
130	\$492.97	\$343.79
260	\$694.22	\$545.04

- ❖ Refer to the Company's Tariff, Part III, Original Sheet No. 37 – 39 for additional detail information.

Jersey Central Power & Light <small>A FirstEnergy Company</small>			STANDARD COBRA - LED					
LAMP SIZE - IES TYPE III			MONTHLY RATE					
W	LUMENS		COMPANY RATE		CONTRIBUTION RATE (a)		CONTRIBUTION RATE (b)	
	4000K	3000K	Jun -Sep	Oct -May	Jun -Sep	Oct -May	Jun -Sep	Oct -May
30	4,000	3,900	\$.7.90	\$ 7.91	\$ 4.08	\$ 4.09	\$ 5.67	\$ 5.68
50	5,400	5,300	\$ 8.76	\$ 8.79	\$ 4.98	\$ 5.01	\$ 6.57	\$ 6.60
90	9,200	9,000	\$11.10	\$11.14	\$ 6.80	\$ 6.84	\$ 8.39	\$ 8.43
130	14,200	13,700	\$13.86	\$13.92	\$ 8.61	\$ 8.67	\$ 10.20	\$ 10.26
260	28,900	27,800	\$21.84	\$21.96	\$14.45	\$14.57	\$16.04	\$16.16

LED Lumen Values listed are representative of GE manufactured fixtures.

STREET LIGHT MAINTENANCE PROCEDURE

www.firstenergycorp.com

A Municipality can contact the Company at 1-800-662-3115 to report a street light problem. Notification should include a street address, the number of the nearest building, crossroad or landmark, as well as the Municipality. Reporting the pole number, when available, would be very helpful to the Company.

Another way to contact the Company regarding street light problems is to visit our web site at www.jcp-l.com. Once you are on the JCP&L's home page, select "View or Report Outages" from the menu below.

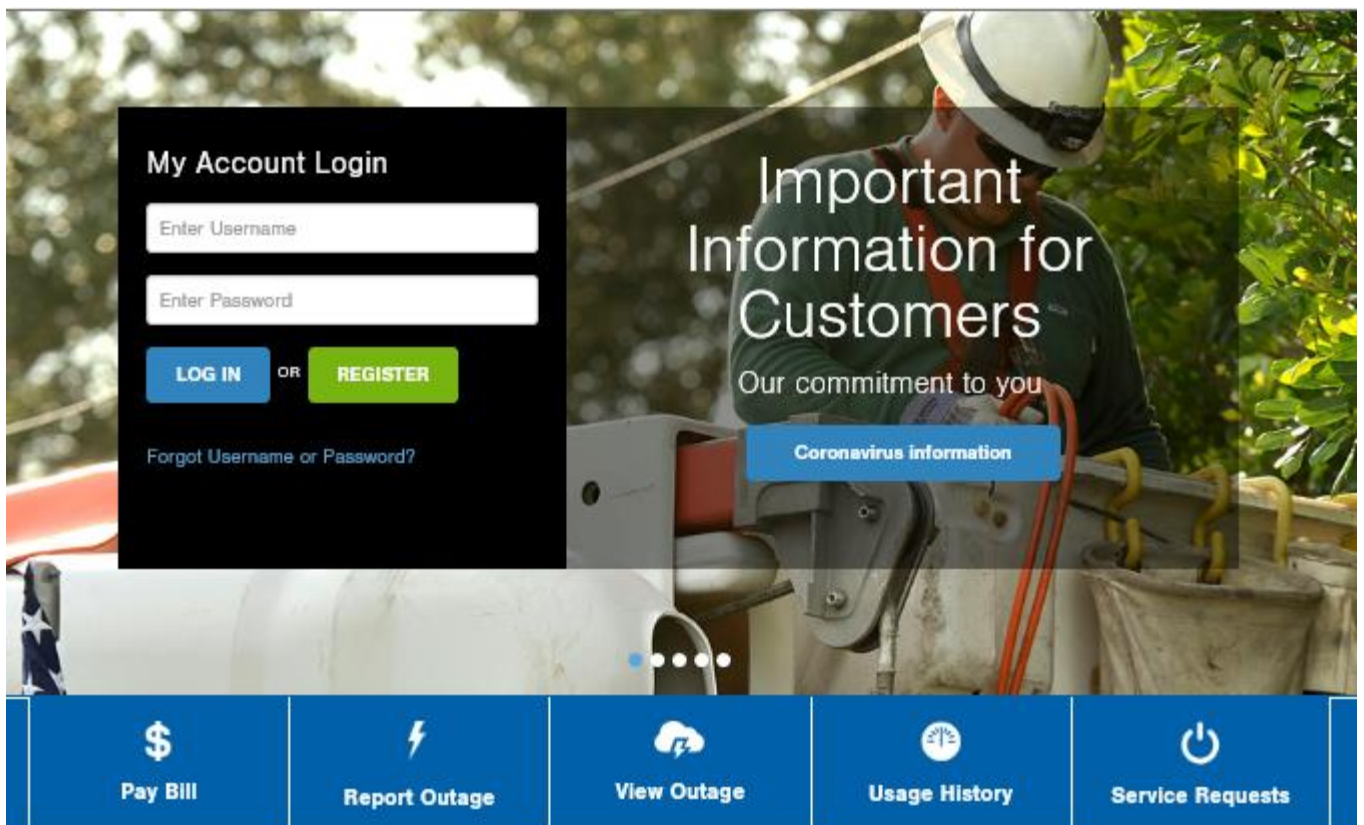

This action will bring you to a page with several options listed on the left. Select "Report Lighting Problem".

BURLINGTON COUNTY

Jarrell Coleman

Chesterfield Township
Mansfield
New Hanover Township
North Hanover Township
Pemberton Borough
Pemberton Township
(Browns Mills)
Southampton Township
Springfield Township
Woodland Township
Wrightstown Borough

MERCER COUNTY

Jarrell Coleman

Robbinsville Township

Tina Earley:

East Windsor Township
Hightstown Borough
Hopewell Township
West Windsor Township

MIDDLESEX COUNTY

Tina Earley

Cranbury Township
East Brunswick Township
Helmetta Borough
Jamesburg Borough
Monroe Township
Old Bridge Township
Sayreville Township (Parlin)
South Amboy City
South Brunswick Township
Spotswood Borough

MONMOUTH COUNTY

Robert Brice

Belmar Borough
Brielle Borough
Farmingdale Borough
Howell Township
Lake Como Borough
Manasquan Borough
Sea Girt Borough
Spring Lake Borough
Spring Lake Heights Borough
Wall Township

Frank Luna

Aberdeen Township
Allenhurst Borough
Asbury Park City
Atlantic Highlands Borough
Avon-By-The-Sea Borough
Bradley Beach Borough
Deal Borough
Eatontown Borough
Fair Haven Borough
Hazlet Township
Highlands Borough
Holmdel Township
Interlaken Borough
Keansburg Borough

MONMOUTH COUNTY cont'd

Frank Luna

Keyport Borough
Little Silver Borough
Loch Arbor Village
Long Branch City
Matawan Borough
Middletown Township-
(Lincroft, Mon Beach,
Navesink)
Monmouth Beach Borough
Neptune City Borough
Neptune Township
Ocean Township
Oceanport Borough
Red Bank Borough
Rumson Borough
Sea Bright Borough
Shrewsbury Borough
Shrewsbury Township
Tinton Falls Borough
Union Beach Borough
West Long Branch Borough

Jarrell Coleman

Upper Freehold Township

Tina Earley

Colts Neck Township
Englishtown Borough
Freehold Borough
Freehold Township
Manalapan Township
Marlboro Township
Millstone Township
Roosevelt Borough

OCEAN COUNTY

Robert Brice

Bay Head Borough
Brick Township
Jackson Township
Lakewood Township
Mantoloking Borough
Pt. Pleasant Beach Borough
Pt. Pleasant Borough

Jarrell Coleman

Barnegat Township
Beachwood Borough
Berkeley Township
Island Heights Borough
Lacey Township
Lakehurst Borough
Lavallette Borough
Manchester Township
Ocean Gate Borough
Ocean Township
Pine Beach Borough
Plumsted Township (New
Egypt)
Seaside Heights Borough
Seaside Park Borough
South Toms River Borough
Toms River Township

**Regional External Affairs Consultant
Central Region**

Robert Brice:

Work: 732-370-7260
rbrice@firstenergycorp.com

Frank Luna:

Work: 732-923-2350
Cellular: 848-273-0561
fluna@firstenergycorp.com

Tina Earley:

Work: 732-723-6652
Cellular: 732-285-2833
tearley@firstenergycorp.com

Jarrell Coleman:

Work: 732-557-6158
Cellular: 732-285-2093
vjacoleman@firstenergycorp.com

<u>Regional External Affairs Consultant County Assignments</u>	
Jarrell Coleman	Burlington
Robert Brice	Ocean
Tina Earley	Middlesex, Mercer
Frank Luna	Monmouth

ESSEX COUNTY

Jolanta Maziarz

Maplewood Township
Millburn Township
Orange Township

Bob Flynn

Livingston Township

HUNTERDON COUNTY

Amy Overman

Alexandria Township
Bethlehem Township
Bloomsbury Borough
Califon Borough
Clinton Town
Clinton Township
Delaware Township
East Amwell Township
Flemington Borough
Franklin Township
Frenchtown Borough
Glen Gardner Borough
Hampton Borough
High Bridge Borough
Holland Township
Kingwood Township
Lambertville City
Lebanon Borough
Lebanon Township
Milford Borough
Raritan Township
Readington Township
Stockton Borough
Tewksbury Township
Union Township
West Amwell Township

MERCER COUNTY

Tina Earley

Hopewell Township

MORRIS COUNTY

Jose Ortiz

Chester Borough
Chester Township
Dover Town
Jefferson Township
Mendham Borough
Mendham Township
Mine Hill Township
Mount Arlington Borough
Mount Olive Township
Netcong Borough
Randolph Township
Rockaway Borough
Rockaway Township
Roxbury Township
Victory Gardens Borough
Washington Twp
Wharton Borough

Bob Flynn

Boonton Town
Boonton Township
Butler Borough
Denville Township
East Hanover Township
Hanover Township
Kinnelon Borough
Lincoln Park Borough
Montville Township
Morris Plains Borough
Mountain Lakes Borough
Parsippany Troy Hills
Township
Pequannock Township
Riverdale

MORRIS COUNTY cont'd

Jolanta Maziarz

Chatham Borough
Chatham Township
Florham Park Borough
Harding Township
Long Hill Township
Madison Borough
Morris Township
Morristown

PASSAIC COUNTY

Bob Flynn

Bloomington Borough
Pompton Lakes Borough
Ringwood Borough
Wanaque Borough
Wayne Township

Jose Ortiz

West Milford Township

SOMERSET COUNTY

Jolanta Maziarz

Bedminster Township
Bernards Township
Bernardsville Borough
Branchburg Township
Bridgewater Township
Far Hills Borough
Green Brook Township
Hillsborough Township
Peapack & Gladstone
Boroughs
Watchung Borough

Bob Flynn

Warren Township

SUSSEX COUNTY

Richard Rebisz

Andover Borough
Andover Township
Branchville Borough
Byram Township
Frankford Township
Franklin Borough
Fredon Township
Green Township
Hamburg Borough
Hampton Township
Hardyston Township
Lafayette Township
Montague Township
Newton Town
Ogdensburg Borough
Sandyston Township
Sparta Township
Stillwater Township
Sussex Borough
Vernon Township
Walpack Township
Wantage Township

Jose Ortiz

Hopatcong Borough
Stanhope Borough

UNION COUNTY

Jolanta Maziarz

Berkeley Heights Twp
Mountainside Borough
New Providence Borough
Springfield Township
Summit City

WARREN COUNTY

Bob Flynn

Alpha Borough
Franklin Township
Greenwich Township
Harmony Township
Lopatcong Township
Oxford Township
Phillipsburg Town
Pohatcong Township
Washington Borough
Washington Township

Jose Ortiz

Hackettstown Town
Independence Township
Mansfield Township

Richard Rebisz

Allamuchy Township
Belvidere Town
Blairstown Township
Frelinghuysen Township
Hackettstown Town
Hardwick Township
Hope Township
Independence Township
Knowlton Township
Liberty Township
White Township

**Regional External Affairs Consultant
Northern Region**

Richard Rebisz:

Work: 973-300-2929
rrebisz@firstenergycorp.com

Bob Flynn:

Work: 973-331-5386
Cellular: 732-772-5527
rflynn@firstenergycorp.com

Jolanta Maziarz

Work: 908-608-5010
Cellular: 732-285-2093
jmaziarz@firstenergycorp.com

Jose Ortiz

Work: 973-537-2660
Cellular: 862-246-1709
ortizj@firstenergycorp.com

Amy Overman

Work: 908-689-6880
Cellular: 862 284-7145
aoverman@firstenergycorp.com

**Regional External Affairs Consultant
County Assignments**

Richard Rebisz	Sussex, Warren
Jose Ortiz	Passaic
Jolanta Maziarz	Union, Essex, Somerset
Bob Flynn	Morris
Amy Overman	Hunterdon

APPROVED STREET LIGHT MANUFACTURES

For your convenience, photometric data can be obtained from the web sites listed below for the following approved street light manufacturers. Search for a particular light using the first three or four letters/numbers from the catalog numbers listed below. Please note that some manufacturers have their own names for the types of lights, such as "Traditionaire", which you will need to cross reference to obtain the correct photometric data.

- ❖ Acuity Lighting..... www.acuitybrands.com
- ❖ American Electric..... www.americanelectriclighting.com
- ❖ Cooper Lighting..... www.cooperlighting.com
- ❖ General Electric..... secure.ge-lightingsystems.com
- ❖ King Luminaire..... www.kingluminaire.com
- ❖ Pemco Lighting..... www.pemcolighting.com

TYPE/SIZE	MANUFACTURER	CATALOG NUMBER
COBRA HEAD LUMINAIRES - Standard Drop Prismatic Refractor (Semi-Cutoff)		
50 watt - 120 volt IES Type II - MSCO	American Electric Cooper Lighting General Electric	115D70B260 (FE) OVZ50SR22EU0019 M2RR05S1N2AMS2
70 watt - 120 volt IES Type III - MSCO	American Electric Cooper Lighting General Electric	115D70E360 (FE) OVZ70SR23EH4 M2RR07S1N2AMS3
100 watt - 120 volt IES Type III - MSCO	American Electric Cooper Lighting General Electric	115D701360 (FE) OVZ10SR23EH4 M2RR10S1N2AMS3
150 watt - 120 volt IES Type III - MSCO	American Electric Cooper Lighting General Electric	115D706360 (FE) OVZ15SR23EH4 M2RR15S1N2AMS3
250 watt - 120 volt IES Type III - MSCO	American Electric Cooper Lighting General Electric	115C623300 (FE) OVZ25S3WW3EH4 M2RR25S1A2GMS3
400 watt - 120 volt IES Type III - MSCO	American Electric Cooper Lighting General Electric	125C624300 (FE) OVX40SW23EU1597 MSRL40S1A22RMS3

TYPE/SIZE	MANUFACTURER	CATALOG NUMBER
COBRA HEAD LUMINAIRES - Low Profile Drop Prismatic Refractor (Cutoff)		
70 watt - 120 volt IES Type II - MCO	American Electric Cooper Lighting General Electric	115D70E2DS (FE) OVG70SR22DU1046 M2RR07SIN2GMS2
100 watt - 120 volt IES Type II - MCO	American Electric Cooper Lighting General Electric	115D7012DS (FE) OVG10SR22DU1047 M2RR10S1N2GMS2
150 watt - 120 volt IES Type II - MCO	American Electric Cooper Lighting General Electric	115D7062DS (FE) OVG15SR22DU1048 M2RR15S1N2GMS2
250 watt - 120 volt IES Type III - MCO	American Electric Cooper Lighting General Electric	115D6233DS (FE) OVG25SW23EU1050 M2RR25S1A2GMS3
400 watt - 120 volt ES Type III - MCO	American Electric Cooper Lighting General Electric	115D6243DS (FE) OVY40SW23EU1051 MSRL40S1A22GMS3
COLONIAL POST TOP LUMINAIRE - Standard		
50 watt - IES Type MS III	Cooper Lighting General Electric Pemco Lighting	LXF50SR233U0282 T10R05S1N2LMS3BL055 RNPF50SVL
70 watt - IES Type MS III	American Electric Cooper Lighting General Electric Pemco Lighting	S-470226-1 LXF70SR233U0001 T10R07S1N2AMS3BL055 RNPF70SVL
70 watt - IES Type V	American Electric Cooper Lighting General Electric	S-470227 LXF70SR255U0116 T10C07S1N2AMS5BL055
100 watt - IES Type MS III	American Electric Cooper Lighting General Electric	24710SRN120R3AYEC LXF10SR23H4 T10R10S1N2AMS3BLT

TYPE/SIZE	MANUFACTURER	CATALOG NUMBER
COLONIAL POST TOP LUMINAIRE - Standard (cont'd)		
100 watt IES Type V	American Electric Cooper Electric General Electric	24710SRN120R5AYECAR10731 LXF10SR255U0117 T10C10S1N2AMS5BL055
150 watt IES Type MS III	American Electric Cooper Electric General Electric	24715SRN120R3AYEC LXF15SR23H4 T10R15S1N2AMS3BLT
COLONIAL POST TOP LUMINAIRE – Ornate		
70 watt – MS III	Acuity Lighting Cooper Lighting	AVP07S4N120R3PYTLVX UTD 9007 BK
70 watt – V	Acuity Lighting Cooper Lighting	AVP07SRN120R5PYTLVX UTD 9008 BK
100 watt – MS III	Acuity Lighting Cooper Lighting	AVP10SRN120R3PYTLVX UTD 9009 BK
100 watt – V	Cooper Lighting	UTD 009010 BK
ACORN STYLE POST TOP LUMINAIRE		
70 watt – MS II	King Luminaire	K199-EAR-II-70-SVL-120-K12-PR
70 watt – V	King Luminaire	K199-EAR-V-70-SVL-120-K12-PR
100 watt – MS II	King Luminaire	K199-EAR-II-100-SVL-120-K12-PR
100 watt – V	King Luminaire	K199-EAR-V-100-SVL-120-K12-PR

LED Manufactures

TYPE/SIZE	MANUFACTURER	CATALOG NUMBER
COBRA HEAD LUMINAIRES - Standard		
50 & 90 watt IES Type III	General Electric	ERLC GE (50) ERL1 GE (90)
130 watt IES Type III 260 watt IES Type III	General Electric	ERLH GE ERS2 GE
COLONIAL POST TOP LUMINAIRE		
50 watt IES Type III	Cooper Lighting	UTR Cooper
50 watt IES Type V	Cooper Lighting	UTR Cooper
90 watt IES Type III	Cooper Lighting	UTR Cooper
90 watt IES Type V	Cooper Lighting	UTR Cooper
ACORN STYLE POST TOP LUMINAIRE		
50 watt IES Type III	Cooper Lighting	ACN Cooper
50 watt IES Type V	Cooper Lighting	ACN Cooper
90 watt IES Type III	Cooper Lighting	ACN Cooper
90 watt IES Type V	Cooper Lighting	ACN Cooper

Annualized Cost Comparison Based on Lumens & Type of Light

Jersey Central Power & Light Company

Rates effective August 1, 2020

Annualized Cost Comparison based on Lumens and type of light – LED vs SVL, MVL, ISL

Cobra Head Lamp Wattage	Lamp Ballast Wattage	Source/ Delivered Lumens*	Billing Month kWh**	Company Fixture Charge	kWh Charges	Total Monthly Charge (1)	Monthly Price difference	Monthly Percentage Savings	LED Energy Savings
LED 50 W		5300	18	\$6.43	\$2.35	\$8.78			
SVL 50 W	60	2800	21	\$6.48	\$2.74	\$9.22	(\$0.44)	-5%	-14%
SVL 70 W	85	4410	30	\$6.48	\$3.92	\$10.40	(\$1.62)	-16%	-40%
MVL 100 W	121	2800	42	\$4.52	\$5.48	\$10.00	(\$1.22)	-12%	-57%
MVL 175 W	211	5390	74	\$4.52	\$9.66	\$14.18	(\$5.40)	-38%	-76%
ISL 105 W		1000	37	\$1.91	\$4.83	\$6.74	\$2.04	30%	-51%
ISL 205 W		2500	72	\$1.91	\$9.40	\$11.31	(\$2.53)	-22%	-75%
ISL 327 W		4000	114	\$1.91	\$14.88	\$16.79	(\$8.01)	-48%	-84%
ISL 448 W		6000	157	\$1.91	\$20.49	\$22.40	(\$13.62)	-61%	-89%
LED 90 W		9000	32	\$6.95	\$4.18	\$11.13			
SVL 100 W	121	6650	42	\$6.48	\$5.48	\$11.96	(\$0.84)	-7%	-24%
MVL 250 W	295	8400	103	\$4.52	\$13.44	\$17.96	(\$6.84)	-38%	-69%
LED 130 W		13700	46	\$7.90	\$6.00	\$13.90			
SVL 150 W	176	11200	62	\$6.48	\$8.09	\$14.57	(\$0.67)	-5%	-26%
ISL 690 W		10000	242	\$1.91	\$31.59	\$33.50	(\$19.60)	-59%	-81%
LED 260 W		27800	91	\$10.04	\$11.88	\$21.92			
SVL 250 W	293	19250	103	\$7.67	\$13.44	\$21.11	\$0.81	4%	-12%
MVL 400 W	468	15750	164	\$4.90	\$21.41	\$26.31	(\$4.39)	-17%	-45%
SVL 400 W	498	35000	174	\$7.67	\$22.71	\$30.38			
MVL 700 W	803	28000	281	\$5.94	\$36.68	\$42.62	(\$12.23)	-29%	-38%
MVL 1000 W	1135	60500	397	\$5.94	\$51.82	\$57.76			

* Delivered Lumens provided for comparison purposes between LED, MVL and SVL are those for Cobra Head type Fixtures. LED Lumen Values are those for 3000 Kelvin Temperature, and representative of GE manufactured fixtures. MVL and SVL lumen values are at 70% of source lumens due to loss of trapped Lumens.

** Based on standard illumination schedule of 4200 hours per year, Billing Month KWH was calculated to the nearest whole KWH based on the Lamp wattage of the light, or the nominal lamp and ballast wattage of the light, times the light's annual burning hours per year, divided by 12 months per year, divided by 1000 watts per KWH.